

LED VANITY BATH BAR, SELECTABLE 5CCT
ITM: 1011-18W-XX-LED 1011-18W-XXXX-LED
1011-25W-XX-LED 1011-25W-XXXX-LED
1011-32W-XX-LED 1011-32W-XXXX-LED
1011-40W-XX-LED 1011-40W-XXXX-LED

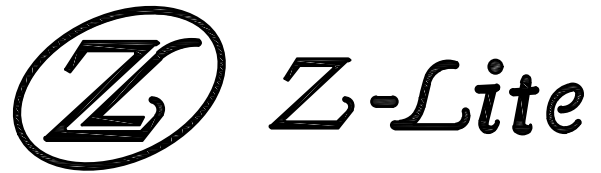

Please consult a qualified electrician for hanging fixture and wiring.
CAUTION: Before starting the installation, disconnect removing the fuse at the fuse box.
 Carefully unpack and identify all parts before assembly.

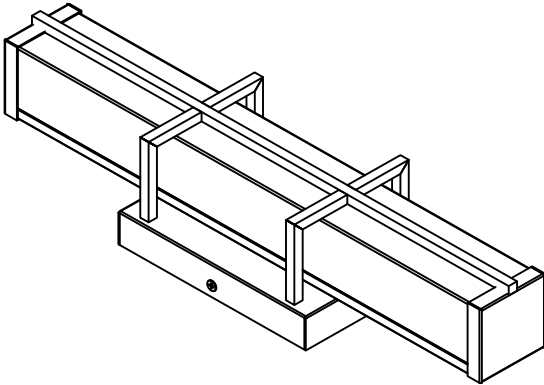

1. Always disconnect power at the main electrical panel before installation.

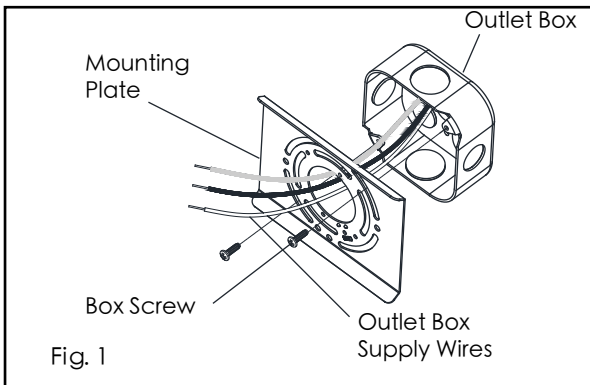

2. Pull wall box wires through center hole of mounting plate. Secure mounting plate to wall using screws so that the fixture mounting points are aligned vertically. (See Fig. 1)

Turn off the light before Switching.

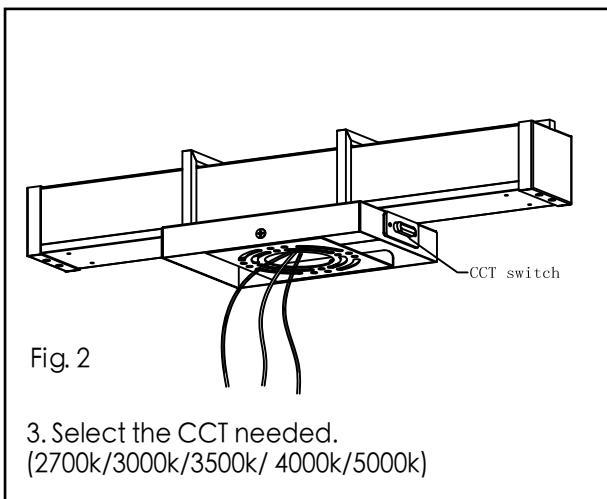

Fig. 2

3. Select the CCT needed.
 (2700k/3000k/3500k/ 4000k/5000k)

4. Follow wiring instructions Fig.3 and Fig.4

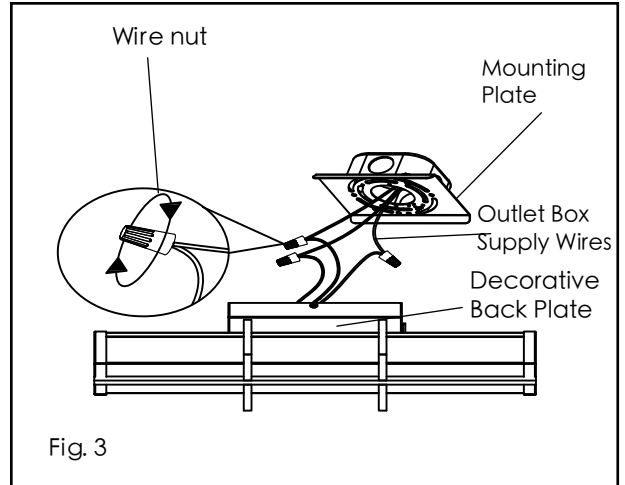
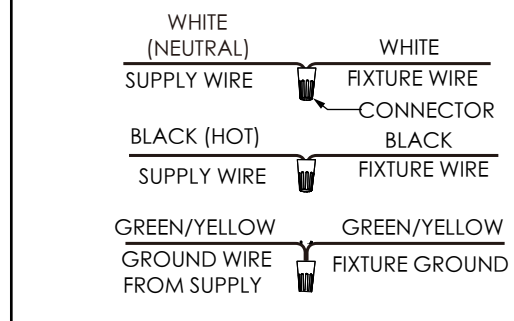

Fig. 3

Fig. 4 Wiring guide



5. After connecting all wires, push all wires and wirenuts back through center hole of mounting plate and into the cavity of the electrical box, while positioning the fixture to align with the mounting points / tabs.

6. Secure decorative back plate with screws at the top and the bottom to the mounting plate. (See Fig. 5)

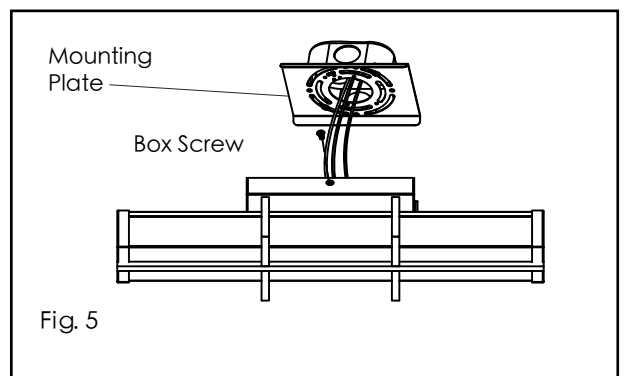

Fig. 5